

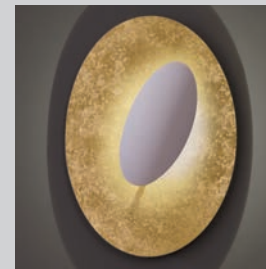

# NOVITÀ - NEWS



**MASAI** pag 4



**ESSENZA** pag 22



**ALBATROS** pag 32



**DUETTO** pag 36



**GRU** pag 42



**PETRA** pag 46



**CRISTALGLOB** pag 66



**HULA HOOP** pag 76



**VERA** pag 84

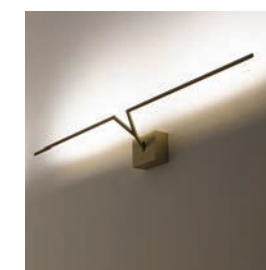

**YPSILON** pag 94

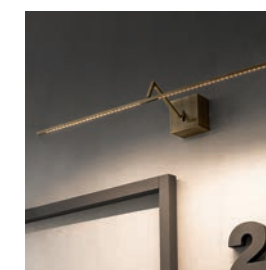

**ZETA** pag 98



**LADY B** pag 102

# MASAI

Design: Marco Pagnoncelli - 2022



BI	Bianco	BI+BS	Bianco + Bronzo Spazzolato
PO+BS	Polvere oro + Bronzo Spazzolato	BI+NE	Bianco + Nero
PO+BI	Polvere oro + Bianco	PA+FS	Polvere argento + Ferro spazzolato
PO+NE	Polvere oro + Nero	BI+FS	Bianco + Ferro spazzolato

Lampada da terra in alluminio curvato su quale viene proiettata la luce da un proiettore in alluminio pessofuso ovale. Illuminazione a led ad alta efficienza a luce indiretta.

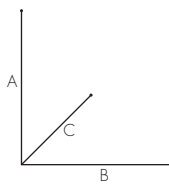

Art.	W	V	Lumen	°K led	A cm	B cm	C cm	LED
MASAI <b>ST 20</b>	20	220	1920	2700/3000	138	64	30	220V CRI90
MASAI <b>ST 53</b>	53	220	6920	2700/3000	138	64	30	220V - 24V CRI90

DIMMERABILI

MASAI ST 53 P.O. BS  
Polvere oro + Bronzo spazzolato



**MASAI LG** PA.FS  
 Polvere argento + Ferro spazzolato



**MASAI LP** BI.FS  
 Bianco + Ferro spazzolato

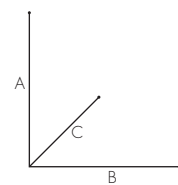

Art.	W	V	Lumen	°K led	A cm	B cm	C cm	LED
MASAI LP	15	220	1350	2700/3000	49	28	14	220V CRI90
MASAI LG	20	220	1920	2700/3000	74	44	20	220V CRI90

DIMMERABILI

MASAI 90 S BA.FS

Polvere argento + Ferro spazzolato



MASAI 130 S BI.BS

Bianco + Bronzo spazzolato

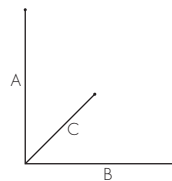

Art.	W	V	Lumen	°K led	A cm	B cm	C cm	LED
MASAI 90 S	45	220	5190	2700/3000	200	90	50	220V CRI90
MASAI 130 S	60	220	5760	2700/3000	200	130	64	220V CRI90

DIMMERABILE TRIAC

**MASAI 50** P.O.BI  
 Polvere oro + Bianco



**MASAI 70** P.O.BI  
 Polvere oro + Bianco

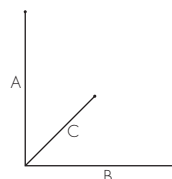
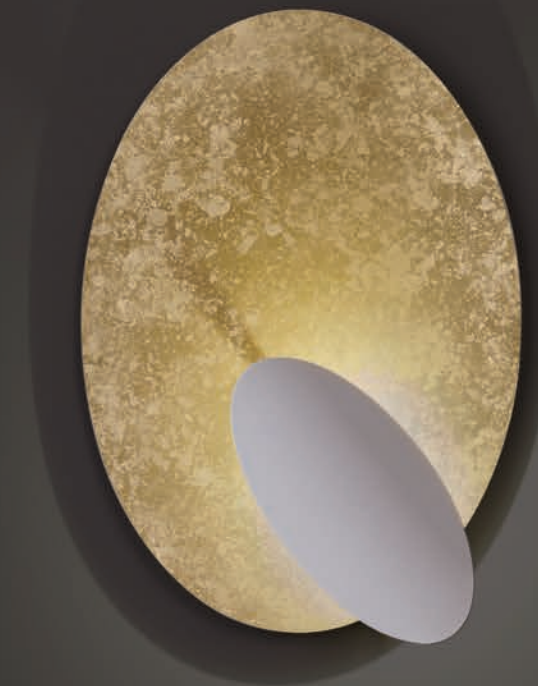

Art.	W	V	Lumen	°K led	A cm	B cm	C cm	LED
MASAI <b>50</b>	15	220	1350	2700/3000	50	36	14	220V CRI90
MASAI <b>70</b>	20	220	1920	2700/3000	70	44	16	220V CRI90

DIMMERABILE TRIAC

**MASAI 70** BI  
Bianco



**MASAI 90** PO . NE  
Polvere oro + Nero

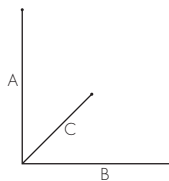

Art.	W	V	Lumen	°K led	A cm	B cm	C cm	LED
MASAI <b>70</b>	20	220	1920	2700/3000	70	44	16	220V CRI90
MASAI <b>90</b>	40	220	3840	2700/3000	90	60	18	220V CRI90

DIMMERABILE TRIAC

MASAI AP 20 PO.NE  
 Polvere oro + Nero

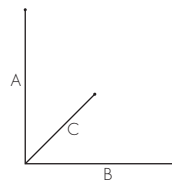

Art.	W	V	Lumen	°K led	A cm	B cm	C cm	LED
MASAI AP 20	20	220	1920	2700/3000	50	28	18	220V CRI90

DIMMERABILE TRIAC





MASAI AP 15 BI.BS  
Bianco + Bronzo spazzolato

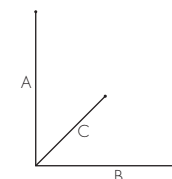

Art.	W	V	Lumen	°K led	A cm	B cm	C cm	LED
MASAI AP 15	15	220	1350	2700/3000	38	22	16	220V CRI90
DIMMERABILE TRIAC								



**MASAI AP.P** BI  
Bianco



**MASAI AP.G** BI  
Bianco

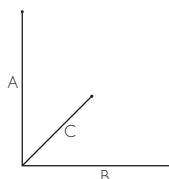

Art.	W	V	Lumen	°K led	A cm	B cm	C cm	LED
MASAI <b>AP P</b>	15	220	1350	2700/3000	25	14	13	220V CRI90
MASAI <b>AP G</b>	20	220	1920	2700/3000	36	18	18	220V CRI90

DIMMERABILE TRIAC



**MASAI ST 45** B S  
Bronzo spazzolato

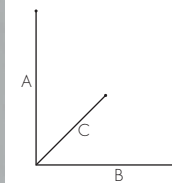

Art.	W	V	Lumen	°K led	A cm	B cm	C cm	LED
MASAI ST 45	45	220	4050	2700/3000	183	30	30	220V CRI90

DIMMERABILE

# ESSENZA

Design: Marco Pagnoncelli - 2022

BI	Bianco	BI+BS	Bianco + Bronzo Spazzolato
PO+BS	Polvere oro + Bronzo Spazzolato	BI+NE	Bianco + Nero
PO+NE	Polvere oro + Nero	BI+FS	Bianco + Ferro spazzolato
PO+BI	Polvere oro + Bianco	PA+BI	Polvere argento + Bianco
RU+BS	Ruggine + Bronzo Spazzolato	PA+FS	Polvere argento + Ferro spazzolato



Collezione a luce indiretta realizzata da un disco riflettente in alluminio di diverse finiture sul quale viene proiettata la luce proveniente da due profili di sezione quadrata 7x7 millimetri. Illuminazione a led ad alta efficienza.

ESSENZA 47 D PO . BS  
Polvere oro + Bronzo spazzolato





**ESSENZA 30 D PO.BS**  
 Polvere oro + Bronzo spazzolato



**ESSENZA 90 D PO.NE**  
 Polvere oro + Nero

Art.	W	V	Lumen	°K led	A cm	B cm	C cm	LED
ESSENZA <b>90 D</b>	35	220	4000	2700/3000		90	13,5	24V CRI90
ESSENZA <b>70 D</b>	25	220	3080	2700/3000		70	13,5	24V CRI90
ESSENZA <b>47 D</b>	17	220	2150	2700/3000		47	11	24V CRI90
ESSENZA <b>30 D</b>	11	220	1230	2700/3000		30	9,5	24V CRI90

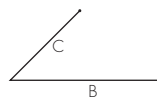

ALIMENTATORE INCLUSO/DRIVER INCLUDED  
 DIMMERABILE TRIAC



**ESSENZA 90 D R.U.B.S**  
Rugine + Bronzo spazzolato

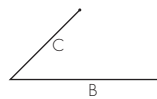

Art.	W	V	Lumen	°K led	A cm	B cm	C cm	LED
ESSENZA <b>90</b>	35	220	4000	2700/3000	90	13,5	24V CRI90	
ESSENZA <b>70</b>	25	220	3080	2700/3000	70	13,5	24V CRI90	
ESSENZA <b>47</b>	17	220	2150	2700/3000	47	11	24V CRI90	
ESSENZA <b>30</b>	11	220	1230	2700/3000	30	9,5	24V CRI90	

ALIMENTATORE INCLUSO/DRIVER INCLUDED  
DIMMERABILE TRIAC



**ESSENZA 40** PO.NE  
Polvere oro + Nero



**ESSENZA 70** BI.NE  
Bianco + Nero



**ESSENZA 90 S** Bl. BS

Bianco + Bronzo spazzolato

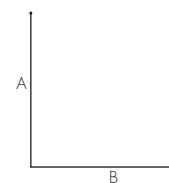

Art.	W	V	Lumen	°K led	A cm	B cm	C cm	LED
ESSENZA <b>90 S</b>	50	220	5500	2700/3000	200	90		24V CRI90



# ALBATROS

Design: Marco Pagnoncelli - 2022

ALBATROS 100 AR.OT  
Ardesia + Ottone satinato

BE+OT Bianco etrusco + Ottone satinato  
AR+OT Ardesia + Ottone satinato

Collezione ad alto impatto scenografico realizzata da una struttura scatolare rettangolare effetto pietra, sulla quale viene proiettata la luce prodotta da tre astine di sezione quadrata curvate e orientabili in senso rotatorio.



# ALBATROS 145 BE.OT

Bianco etrusco + Ottone satinato

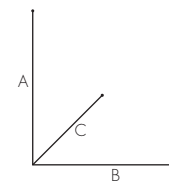
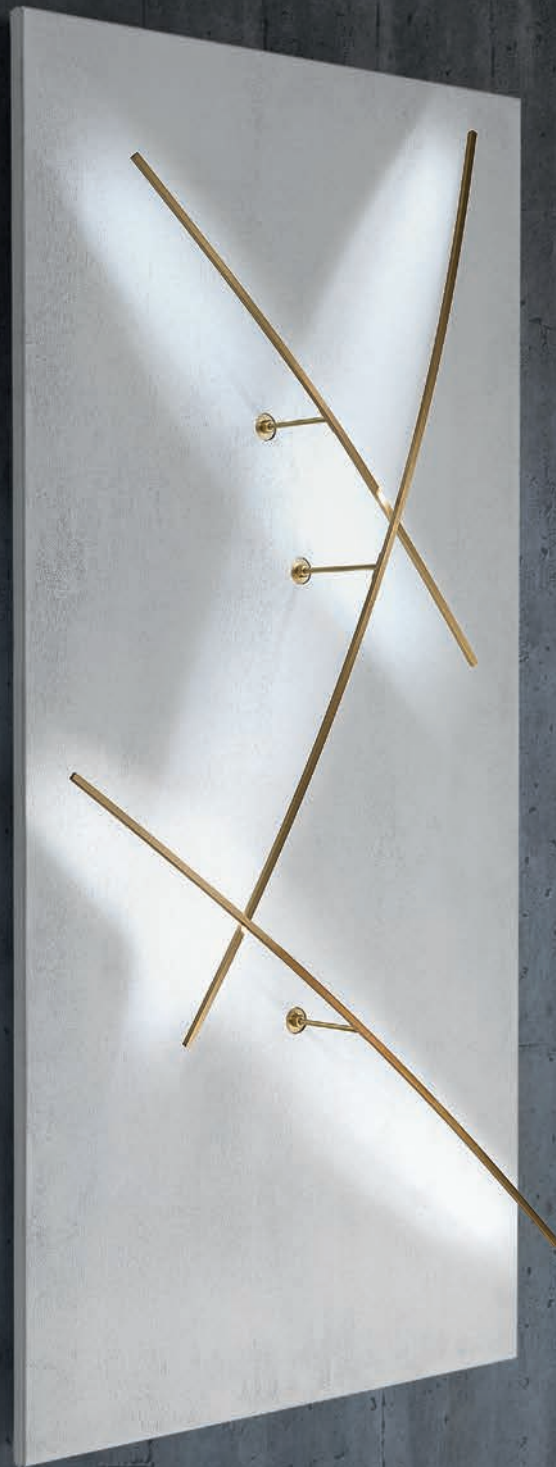

Art.	W	V	Lumen	°K led	A cm	B cm	C cm	LED
ALBATROS <b>145</b>	45	220	2640	2700/3000	145	70	18	24V CRI90
ALBATROS <b>100</b>	30	220	1510	2700/3000	100	50	17	24V CRI90

# DUETTO

Design: Mario Ornaghi - 2022

BI	Bianco	BS+PO	Bronzo Spazzolato + Polvere oro
BI+PO	Bianco + Polvere oro	BS+BI	Bronzo Spazzolato + Bianco
NE+BI	Nero + Bianco	FS+PA	Ferro Spazzolato + Polvere argento
NE+PO	Nero + Polvere oro		



Sospensione in alluminio tornito realizzata in diverse finiture di colore.  
Illuminazione a led indiretto con un ottimo confort luminoso conferito dall'anello luminoso che proietta la luce verso l'interno della lampada.



**DUETTO 55 G** F.S.P.A.  
Ferro spazzolato + Polvere argento

**DUETTO 55 G** BS . PO  
 Bronzo spazzolato + Polvere oro

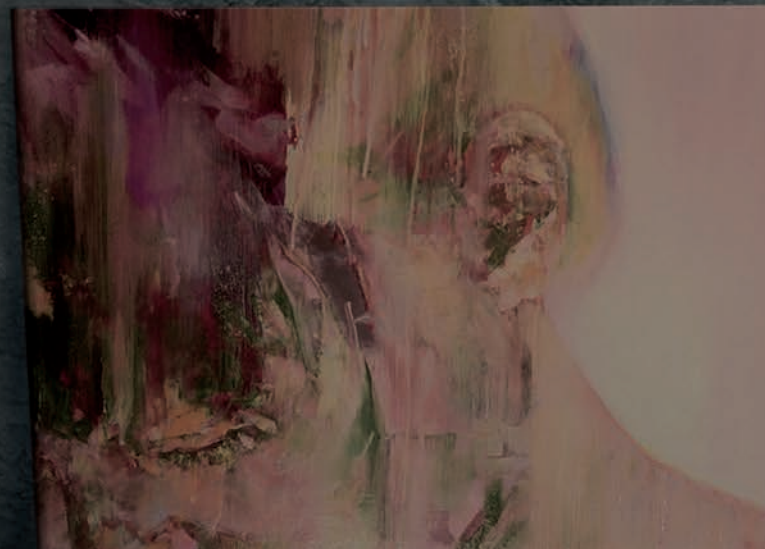

**DUETTO 35 G** NE . BI  
 Nero + Bianco

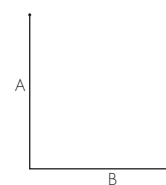

Art.	W	V	Lumen	°K led	A cm	B cm	C cm	LED
DUETTO <b>55 G</b>	25	220	3697	2700/3000	200	55		24V CRI90
DUETTO <b>35 G</b>	13	220	2100	2700/3000	200	35		24V CRI90

DIMMERABILE TRIAC

“

CON LE FINITURE RIUSCIAMO  
con le finiture riusciamo

A DARE ALLA LAMPADA  
a dare alla lampada

UN EFFETTO MATERICO  
un effetto materico

”

Marco Pagnoncelli

**iC**  
ICONE



Gru  
MARCO PAGNONCELLI





Petra  
MARCO PAGNONCELLI



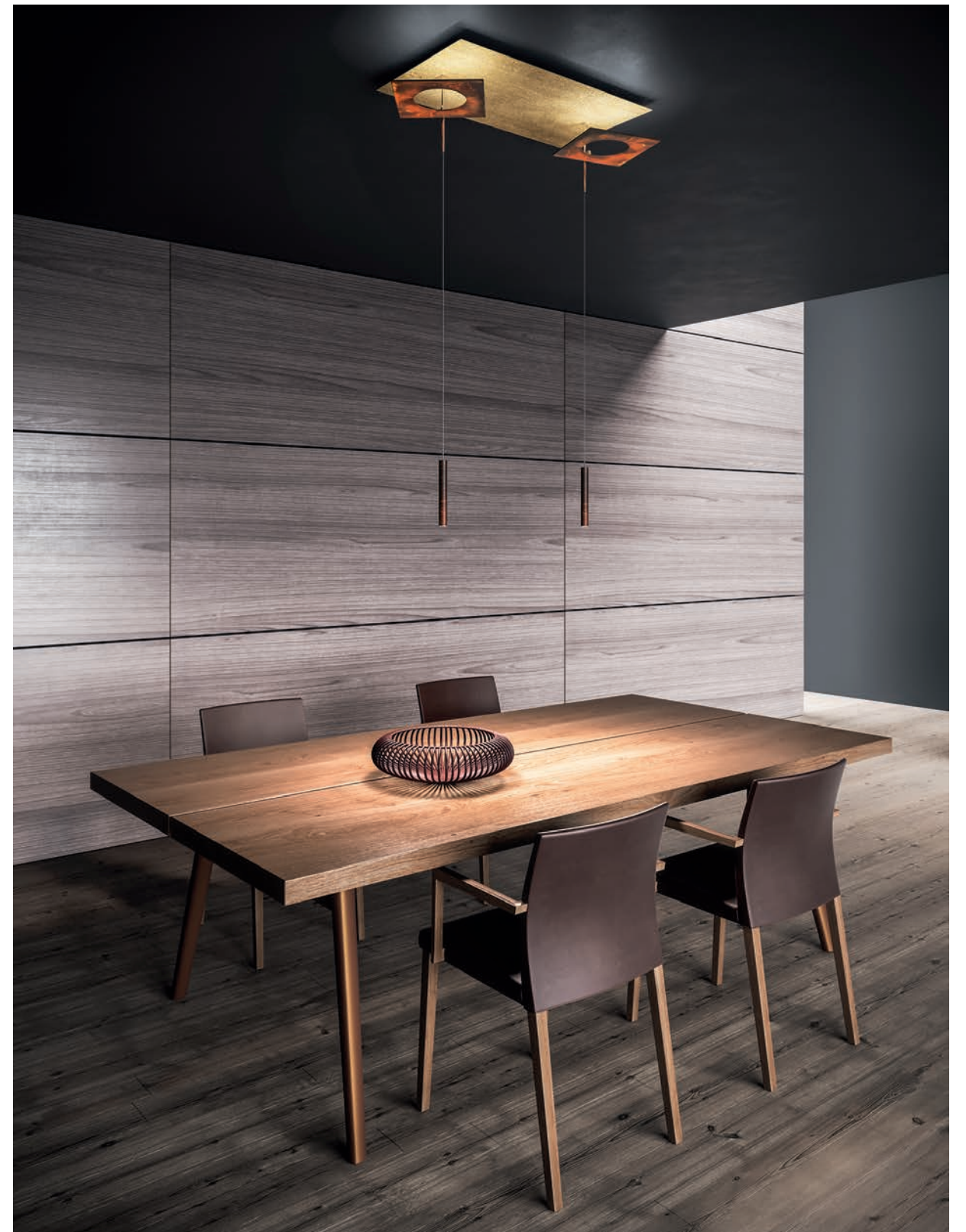

per varianti colori vedere pagina 61 | for color matchings see page 61



Petra



per varianti colori vedere pagina 61 | for color matchings see page 61

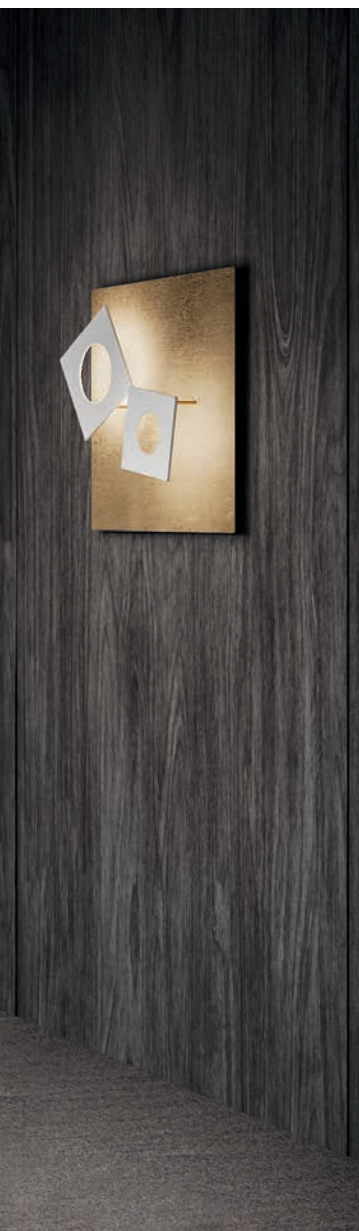

per varianti colori vedere pagina 61 | for color matchings see page 61



per varianti colori vedere pagina 61 | for color matchings see page 61

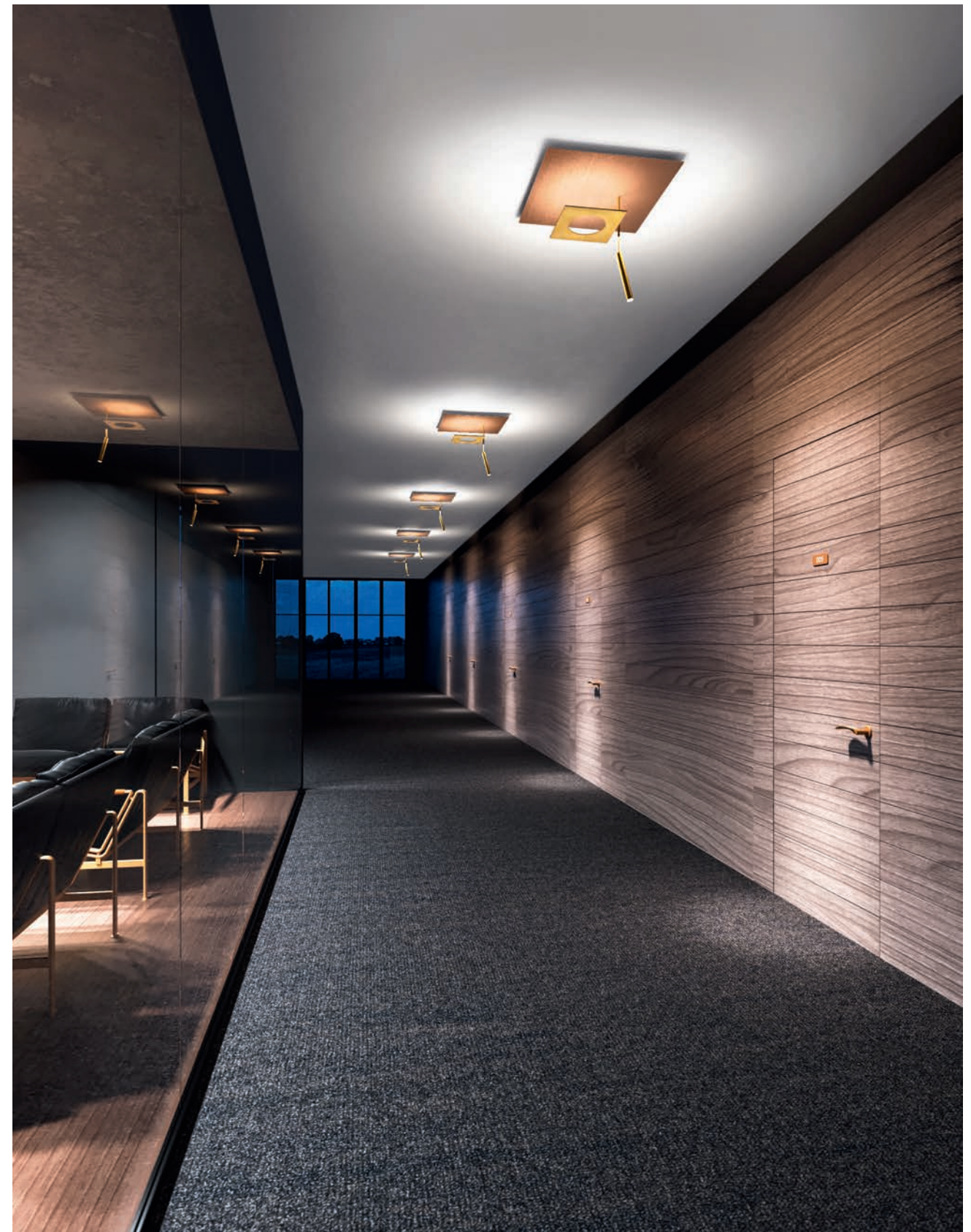



Petra



Bianco / Ruggine  
White / Rust



Bianco / Bianco  
White / White



Bianco / Alluminio satinato  
White / Satin aluminum



Ecrù / Ottone satinato  
Ecrù / Satin Brass



Ecrù / Nero  
Ecrù / Black



Ecrù / Alluminio satinato  
Ecrù / Satin aluminum



Oro etrusco / Bianco  
Etruscan gold / White



Oro etrusco / Ruggine  
Etruscan gold / Rust



Oro etrusco / Nero  
Etruscan gold / Black



Rame etrusco / Ottone satinato  
Etruscan copper / Satin Brass



Rame etrusco / Bianco  
Etruscan copper / White



Argento etrusco / Ottone satinato  
Etruscan silver / Satin brass



Nero ardesia / Alluminio satinato  
Slate black / Satin aluminum



Bianco  
White



Ecrù  
Ecrù



Rame etrusco  
Etruscan copper



Argento etrusco  
Etruscan silver



Oro etrusco  
Etruscan gold



Ottone satinato  
Satin brass



Alluminio satinato  
Satin aluminum

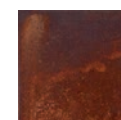

Ruggine  
Rust



Nero ardesia  
Slate black



Nero  
Black

# Petra 31 | Petra 26 | Petra 21

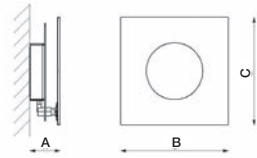

PETRA ... TRIAC = DIMMERABILE TRIAC

ALIMENTATORE INCLUSO | DRIVER INCLUDED.

Art.	W	V	Lumen	°K LED	A cm	B cm	C cm	LED
PETRA 31	25,2	220	3697	2700/3000	7	31	31	700mA CRI90
PETRA 26	16,8	220	2598	2700/3000	7	26	26	700mA CRI90
PETRA 21	13,5	220	2100	2700/3000	7	21	21	700mA CRI90

# Petra.2

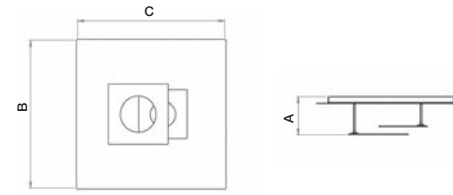

PETRA ... TRIAC = DIMMERABILE TRIAC

ALIMENTATORE INCLUSO | DRIVER INCLUDED.

Art.	W	V	Lumen	°K LED	A cm	B cm	C cm	LED
PETRA.2								
proiettore	25,2	220	3697	2700/3000	18	66	66	700mA CRI90
proiettore spot	16,8	220	2598	2700/3000				700mA CRI90
totale	42,0	220	6295	2700/3000				700mA CRI90

# Petra 66 | Petra 50 | Petra 40

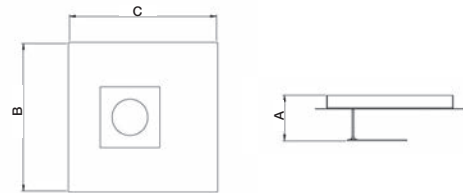

PETRA ... TRIAC = DIMMERABILE TRIAC

ALIMENTATORE INCLUSO | DRIVER INCLUDED.

Art.	W	V	Lumen	°K LED	A cm	B cm	C cm	LED
PETRA 66	25,2	220	3697	2700/3000	20	66	66	700mA CRI90
PETRA 50	16,8	220	2598	2700/3000	20	50	50	700mA CRI90
PETRA 40	13,5	220	2100	2700/3000	20	43	43	700mA CRI90

# Petra P2.66 | Petra P2.50 | Petra P2.40

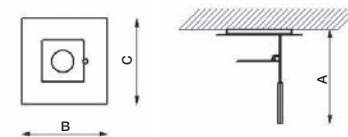

PETRA ... TRIAC = DIMMERABILE TRIAC

ALIMENTATORE INCLUSO | DRIVER INCLUDED.

Art.	W	V	Lumen	°K LED	A cm	B cm	C cm	LED
PETRA P2.66								
proiettore	25,2	220	3697	2700/3000	45	66	66	700mA CRI90
spot	11	220	1500	2700/3000				700mA CRI90
totale	36,2	220	5197	2700/3000				700mA CRI90
PETRA P2.50								
proiettore	16,8	220	2598	2700/3000	45	50	50	700mA CRI90
spot	11	220	1500	2700/3000				700mA CRI90
totale	27,8	220	4098	2700/3000				700mA CRI90
PETRA P2.40								
proiettore	13,5	220	2100	2700/3000	45	40	40	700mA CRI90
spot	11	220	1500	2700/3000				700mA CRI90
totale	24,5	220	3600	2700/3000				700mA CRI90

# Petra 21.L

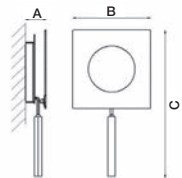

PETRA ... TRIAC = DIMMERABILE TRIAC

ALIMENTATORE INCLUSO | DRIVER INCLUDED.

Art.	W	V	Lumen	°K LED	A cm	B cm	C cm	LED
PETRA 21.L								
proiettore	16,8	220	2598	2700/3000	7	21	38	700mA CRI90
spot	4	220	500	2700/3000				500mA CRI90
totale	20,8	220	3098	2700/3000				700mA CRI90

# Petra.3

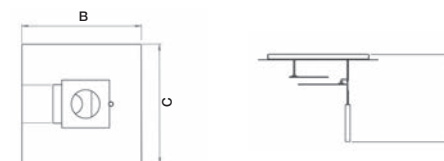

PETRA ... TRIAC = DIMMERABILE TRIAC

ALIMENTATORE INCLUSO | DRIVER INCLUDED.

Art.	W	V	Lumen	°K LED	A cm	B cm	C cm	LED
PETRA.3								
proiettore	25,2	220	3697	2700/3000	45	66	66	700mA CRI90
spot	11	220	1500	2700/3000				700mA CRI90
totale	36,2	220	5197	2700/3000				700mA CRI90



# Petra-S2

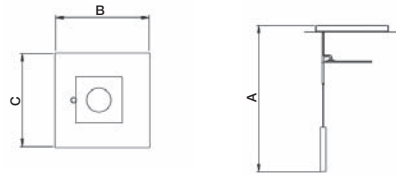

PETRA ... TRIAC = DIMMERABILE TRIAC

ALIMENTATORE INCLUSO | DRIVER INCLUDED

Art. PETRA-S2	W	V	Lumen	°K LED	A cm	B cm	C cm	LED
proiettore	25,2	220	3697	2700/3000	150	66	66	700mA CRI90
spot touch	11	220	1500	2700/3000				700mA CRI90
25/50/75/100%								
<b>totale</b>	<b>36,2</b>	<b>220</b>	<b>5197</b>	<b>2700/3000</b>				<b>700mA CRI90</b>

# kit 400-Petra 66/4<sup>max</sup>-50/3<sup>max</sup>-40/2<sup>max</sup>



KIT LUCE 4 INTENSITÀ+CAVO 4MT PER PETRA 66 MAX 4 PZ.

ALIMENTATORE INCLUSO | DRIVER INCLUDED

Art. KIT 400	W	V	Lumen	°K LED	A cm	LED
	11	220	1500	2700/3000	400	700mA CRI90

# Petra-S4.R

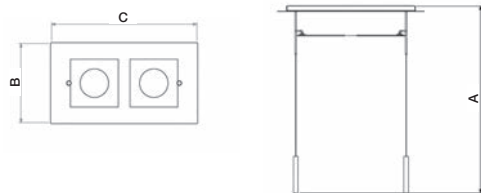

PETRA ... TRIAC = DIMMERABILE TRIAC

ALIMENTATORE INCLUSO | DRIVER INCLUDED

Art. PETRA-S4.R	W	V	Lumen	°K LED	A cm	B cm	C cm	LED
proiettore	33	220	5196	2700/3000	150	40	80	700mA CRI90
spot touch	22	220	3000	2700/3000				700mA CRI90
25/50/75/100%								
<b>totale</b>	<b>55</b>	<b>220</b>	<b>8196</b>	<b>2700/3000</b>				<b>700mA CRI90</b>

# GRU

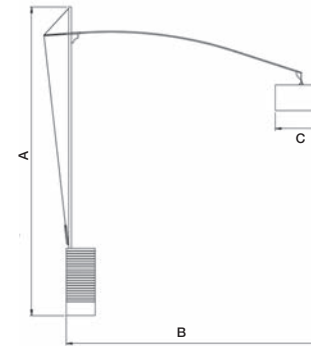

Art. GRU ST	W	V	A cm	B cm	C cm
	1 x max 150	220	230	200	40x20

# Petra-S3

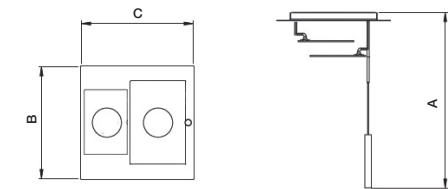

PETRA ... TRIAC = DIMMERABILE TRIAC

ALIMENTATORE INCLUSO | DRIVER INCLUDED

Art. PETRA-S3	W	V	Lumen	°K LED	A cm	B cm	C cm	LED
proiettore	41	220	6295	2700/3000	150	66	66	700mA CRI90
spot touch	11	220	1500	2700/3000				700mA CRI90
25/50/75/100%								
<b>totale</b>	<b>52</b>	<b>220</b>	<b>7795</b>	<b>2700/3000</b>				<b>700mA CRI90</b>



nero/ottone  
black/brass  
(NEOT)



nero/alluminio satinato  
black/satin aluminium  
(NEAS)



Cristalglob  
MARCO PAGNONCELLI





# Cristalglob



## rosone / canopy 4

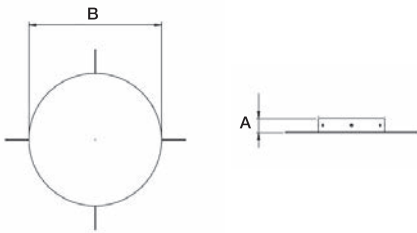

Art. ROSONE CANOPY 4	W 37	V 220	A cm 4,5	B cm 30
----------------------------	---------	----------	-------------	------------

## rosone / canopy 6

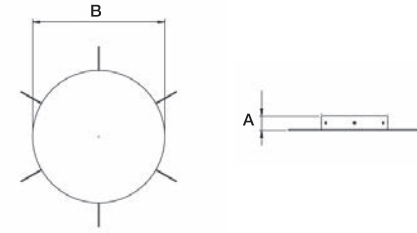

Art. ROSONE CANOPY 6	W 55	V 220	A cm 4,5	B cm 30
----------------------------	---------	----------	-------------	------------

## rosone / canopy 10

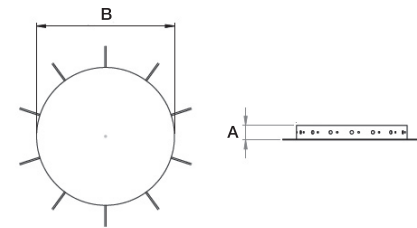

Art. ROSONE CANOPY 10	W 92	V 220	A cm 5	B cm 40
-----------------------------	---------	----------	-----------	------------

## rosone / canopy 14

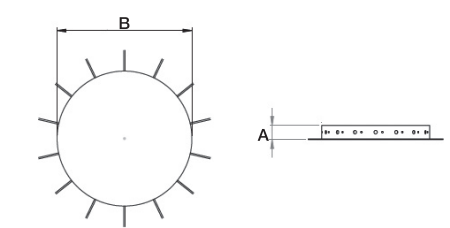

Art. ROSONE CANOPY 14	W 130	V 220	A cm 5	B cm 40
-----------------------------	----------	----------	-----------	------------

## Cristalglob S15 - S33



Art. CRISTALGLOB S15	W 9	V 220	Lumen 1430	°K LED 2700/3000	A cm 150	B cm 15	C cm 40	LED 500 mA CRI90
Art. CRISTALGLOB S33	W 13	V 220	Lumen 1600	°K LED 2700/3000	A cm 180	B cm 33	C cm 60	LED 500 mA CRI90

## kit SFERA 15



Art. KIT SFERA 15	W 9	Lumen 1430	°K LED 2700/3000	A cm 400	B cm 15	C cm 40	LED 500 mA CRI90
----------------------	--------	---------------	---------------------	-------------	------------	------------	---------------------

## Cristalglob LP

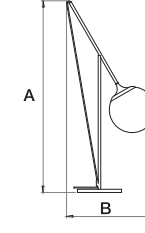

Art. SFERA DA TAVOLO	W 9	V 220	Lumen 1430	°K LED 2700/3000	A cm 60	B cm 28	LED 500 mA CRI90
----------------------------	--------	----------	---------------	---------------------	------------	------------	---------------------

## Cristalglob AP

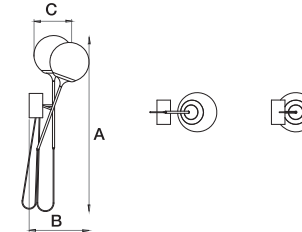

Art. APPLIQUE	W 9	V 220	Lumen 1430	°K LED 2700/3000	A cm 40	B cm 20	C cm 15	LED 500 mA CRI90
------------------	--------	----------	---------------	---------------------	------------	------------	------------	---------------------

## Cristalglob ST

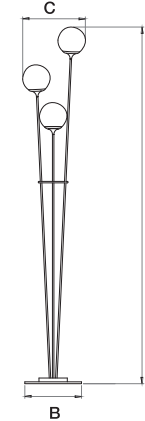

Art. SFERA A PIANTANA	W 39	V 220	Lumen 4290	°K LED 2700/3000	A cm 190	B cm 30	C cm 35	LED 500 mA CRI90
-----------------------------	---------	----------	---------------	---------------------	-------------	------------	------------	---------------------



cristallo/ottone  
cristal/brass  
(OTCO)



cristallo/bianco  
cristal/white  
(BICO)



rosa/ottone  
pink/brass  
(OTRO)



rosa/bianco  
pink/white  
(BIRO)





# Hula Hoop

MARCO PAGNONCELLI







# Hula Hoop



## Hula Hoop P2

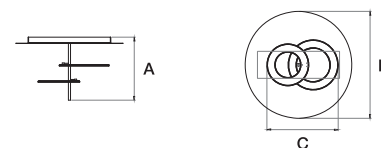

**HULA HOOP ... TRIAC = DIMMERABILE TRIAC**

**ALIMENTATORE INCLUSO | DRIVER INCLUDED.**

Art. PLAFONIERA 2 ANELLI	W 42	V 220	Lumen 7295	°K LED 2700/3000	A cm 40	B cm Ø 66	C cm 44	LED 700 mA CRI90
--------------------------------	---------	----------	---------------	---------------------	------------	--------------	------------	---------------------

## Hula Hoop P3

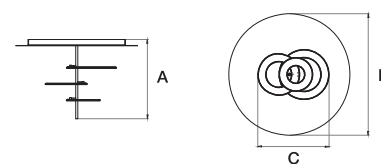

**HULA HOOP ... TRIAC = DIMMERABILE TRIAC**

**ALIMENTATORE INCLUSO | DRIVER INCLUDED.**

Art. PLAFONIERA 3 ANELLI	W 55	V 220	Lumen 8395	°K LED 2700/3000	A cm 50	B cm Ø 75	C cm 50	LED 700 mA CRI90
--------------------------------	---------	----------	---------------	---------------------	------------	--------------	------------	---------------------

## Hula Hoop S2

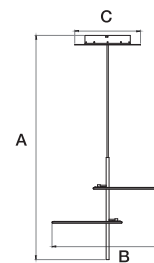

**ALIMENTATORE INCLUSO | DRIVER INCLUDED.**

Art. SOSPENSIONE 2 ANELLI	W 50	V 220	Lumen 7394	°K LED 2700/3000	A cm 160	B cm Ø 50	C cm 32	LED 700 mA CRI90
---------------------------------	---------	----------	---------------	---------------------	-------------	--------------	------------	---------------------

## Hula Hoop S4

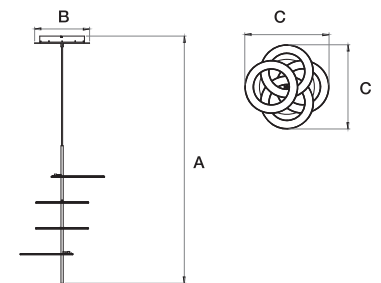

**ALIMENTATORE INCLUSO | DRIVER INCLUDED.**

Art. SOSPENSIONE 4 ANELLI	W 100	V 220	Lumen 14788	°K LED 2700/3000	A cm 160	B cm Ø 32	C cm 50	LED 700 mA CRI90
---------------------------------	----------	----------	----------------	---------------------	-------------	--------------	------------	---------------------

### Abbinamento colori | Color match:

#### Hula Hoop P2-P3



#### Hula Hoop S2-S4

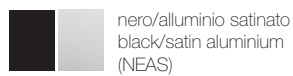



Vera

MARCO PAGNONCELLI



per varianti colori vedere pagina 92-93 | for color matchings see page 92-93



Vera ST





per varianti colori vedere pagina 92-93 | for color matchings see page 92-93

# Vera 31 | Vera 26 | Vera 21

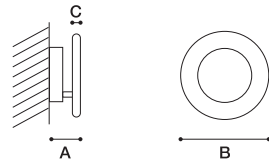

VERA ... TRIAC = DIMMERABILE TRIAC

ALIMENTATORE INCLUSO | DRIVER INCLUDED.

Art.	W	V	Lumen	°K LED	A cm	B cm	C cm	LED
VERA 31	25,2	220	3897	2700/3000	7/36	31	0,6	700mA CRI90
VERA 26	16,8	220	2598	2700/3000	7/32	26	0,6	700mA CRI90
VERA 21	13,5	220	2100	2700/3000	7/27	21	0,6	700mA CRI90

# Vera 66 | Vera 50

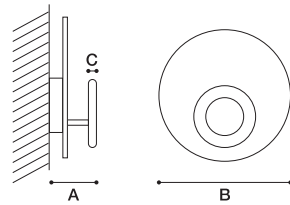

VERA ... TRIAC = DIMMERABILE TRIAC

ALIMENTATORE INCLUSO | DRIVER INCLUDED

Art.	W	V	Lumen	°K LED	A cm	B cm	C cm	LED
VERA 66	25,2	220	3897	3000	17	66	0,6	700mA CRI90
VERA 50	16,8	220	2598	3000	14	50	0,6	700mA CRI90

# Vera ST



Art.	W	V	Lumen	°K LED	A cm	B cm	C cm	D cm	LED
VERA ST	25,2	220	3897	3000	31	190	0,6	27	700mA CRI90

ALIMENTATORE INCLUSO | DRIVER INCLUDED

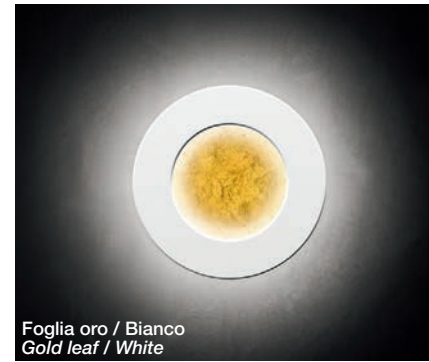
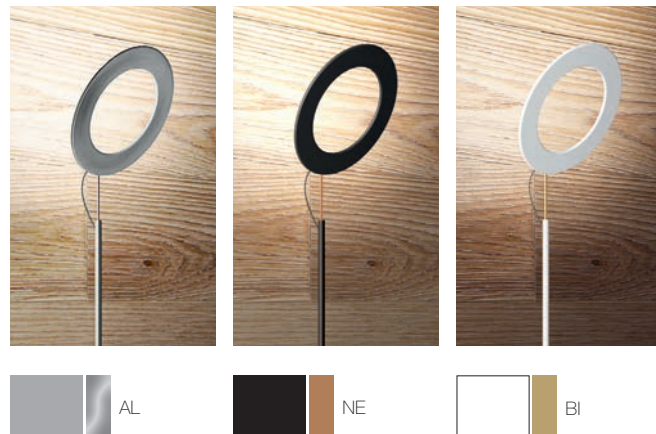
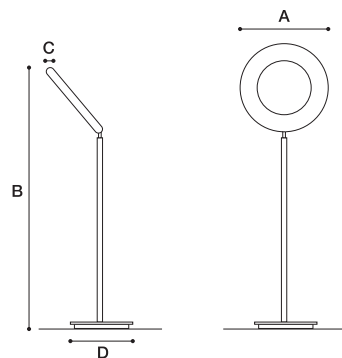

Foglia oro / Bianco  
Gold leaf / White

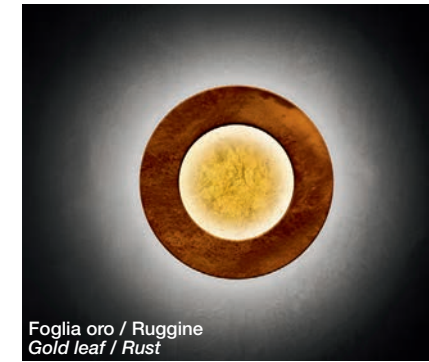

Foglia oro / Ruggine  
Gold leaf / Rust

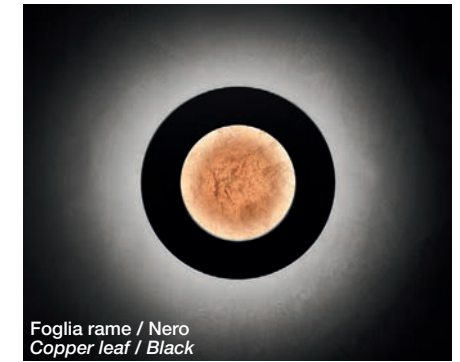

Foglia rame / Nero  
Copper leaf / Black



Bianco / Alluminio spatolato  
White / Brushed aluminium



Bianco / Rame bronzato  
White / Bronzed copper



Bianco / Bianco  
White / White



Bianco / Ottone  
White / Brass

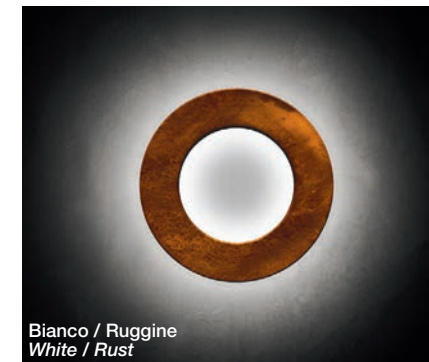

Bianco / Ruggine  
White / Rust

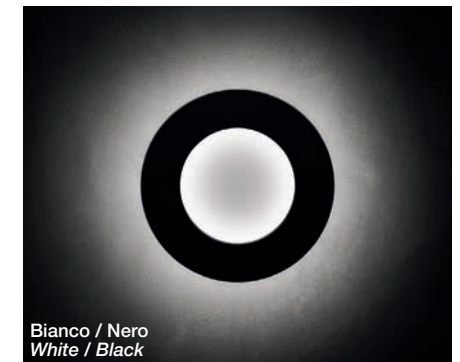

Bianco / Nero  
White / Black

## Abbinamento colori | Color match:

Disco inferiore  
Lower disc  
(da 2mm | 2mm thick)



Bianco  
White

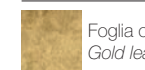

Foglia oro  
Gold leaf

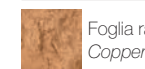

Foglia rame  
Copper leaf

Anello superiore  
Upper ring  
(da 6mm | 6mm thick)



Rame bronzato  
Bronzed copper



Ottone  
Brass



Ruggine  
Rust



Bianco  
White



Nero  
Black



Alluminio spatolato  
Brushed aluminium



Bianco  
White

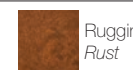

Ruggine  
Rust



Nero  
Black



# Ypsilon

MARCO PAGONCELLI







# Zeta

MARCO PAGNONCELLI





## Ypsilon

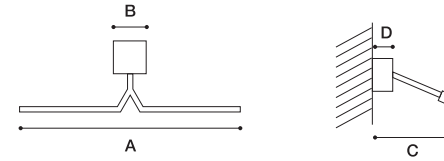

Art.	W	V	Lumen	°K LED	A cm	B cm	C cm	D cm
YPSILON 50	4,80	220	440	3000	50	8	10/17	4,5
YPSILON 70	7,92	220	660	3000	70	8	10/17	4,5
YPSILON 90	10,56	220	880	3000	90	8	10/17	4,5

## Zeta

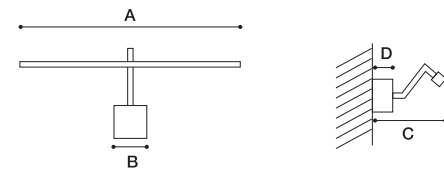

Art.	W	V	Lumen	°K LED	A cm	B cm	C cm	D cm
ZETA 50	4,80	220	440	3000	50	8	17/20	4,5
ZETA 70	7,92	220	660	3000	70	8	17/20	4,5
ZETA 90	10,56	220	880	3000	90	8	17/20	4,5

ALIMENTATORE INCLUSO LED 12V CRI90 | DRIVER INCLUDED LED 12V, CRI90

### Finiture | Finishes:



# Lady B

O.I.L. DESIGN LAB

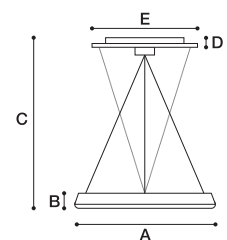

Art.	W	V	Lumen	°K LED
LADY B 800	85	220	9000	2700/3000
LADY B 585	45	220	4500	2700/3000

Art.	A cm	B cm	C cm	D cm	E cm
LADY B 800	80	3,6	150	4,5	28
LADY B 585	58,5	3,6	150	4,5	28

ALIMENTATORE INCLUSO LED 24V CRI90  
DRIVER INCLUDED LED 24V CRI90

## Colori | Colors:



Bianco  
White



Nero  
Black





# COLORI - COLOUR

<b>PE</b>	bianco perla/pearl white
<b>AN</b>	antracite/anthracite
<b>PT</b>	peltro/pewter
<b>BI</b>	bianco/white
<b>NE</b>	nero/black
<b>AL</b>	alluminio lucido/polished aluminium
<b>OS</b>	oro silver/gold silver
<b>RS</b>	rame silver/copper silver
<b>CR</b>	cromo/chrome
<b>OR</b>	oro opaco/matt gold
<b>CI</b>	cioccolato/chocolate
<b>TO</b>	titanio/titanium
<b>FA</b>	foglia argento/silver leaf
<b>FO</b>	foglia oro/gold leaf
<b>BS</b>	bronzo spazzolato/brushed bronze
<b>FR</b>	foglia rame/copper leaf
<b>FE</b>	fumè/smoked
<b>TM</b>	testa di moro/dark brown
<b>OB</b>	old brown
<b>RA</b>	rame/copper
<b>RO</b>	rosa/pink
<b>CO</b>	cristallo/crystal
<b>RU</b>	ruggine/rust
<b>AS</b>	alluminio spazzolato/brushed aluminium
<b>TA</b>	tortora/dove grey
<b>G</b>	grigio/grey
<b>A</b>	alluminio/aluminium
<b>OT</b>	ottone satinato/satin brass
<b>RB</b>	rame bronzato/bronzed copper
<b>OE</b>	oro etrusco/etruscan gold
<b>AE</b>	argento etrusco/etruscan silver
<b>RE</b>	rame etrusco/etruscan copper
<b>EC</b>	ecru/ecru
<b>AR</b>	ardesia/slate
<b>PO</b>	polvere oro/gold powder
<b>PA</b>	polvere argento/silver powder
<b>FS</b>	ferro spazzolato/brushed iron
<b>BE</b>	bianco etrusco/etruscan white

L'azienda si riserva, ferme restando le caratteristiche basilari del prodotto, di apportare senza preavviso tutte le modifiche che riterrà necessarie allo scopo di migliorare la qualità del prodotto stesso. La proprietà, la realizzazione e riproduzione delle caratteristiche estetiche e costruttive qui illustrate sono riservate a termini di legge. I colori hanno valore indicativo in quanto soggetti alle tolleranze dei processi di stampa.

While maintaining the basic characteristics of the product, the Manufacturer reserves the right to make modifications at any time and without any prior notice, with the sole aim of improving the quality of the product. The property, realization and reproduction of aesthetics, design and manufacturing characteristics, here illustrated, are reserved by law. Colours are merely indicative as they are subject to alterations in the printing process.

PROGETTO CREATIVO E STAMPA: **Grafinvest.it** STAMPATO: **Marzo 2022**

È vietata la riproduzione anche parziale di questo catalogo. It is forbidden to reproduce any part of this catalogue.

CATALOGO **2022/2023**



Via Vittorio Veneto, 57  
24041 BREMBATE (BG)-IT  
Tel. +39.035.801239  
Fax +39.035.802989  
italia@iconeluce.com  
export@iconeluce.com  
www.iconeluce.com



ICONE



[iconeluce.com](http://iconeluce.com)